

# Neglected Tropical Diseases

*Infection, modelling and control*



Robert Smith?

Department of Mathematics and Faculty of Medicine  
The University of Ottawa



# NTDs

---

- A group of bacterial and parasitic infections endemic in tropical climates



# NTDs

---

- A group of bacterial and parasitic infections endemic in tropical climates
- Some of the most common infections among the world's poorest people



# NTDs

---

- A group of bacterial and parasitic infections endemic in tropical climates
- Some of the most common infections among the world's poorest people
- Affect rural areas in the developing world



# NTDs

---

- A group of bacterial and parasitic infections endemic in tropical climates
- Some of the most common infections among the world's poorest people
- Affect rural areas in the developing world
- More than 1 billion people infected



# NTDs

---

- A group of bacterial and parasitic infections endemic in tropical climates
- Some of the most common infections among the world's poorest people
- Affect rural areas in the developing world
- More than 1 billion people infected
- Transmission cycles perpetuated by



# NTDs

---

- A group of bacterial and parasitic infections endemic in tropical climates
- Some of the most common infections among the world's poorest people
- Affect rural areas in the developing world
- More than 1 billion people infected
- Transmission cycles perpetuated by
  - environmental contamination



# NTDs

---

- A group of bacterial and parasitic infections endemic in tropical climates
- Some of the most common infections among the world's poorest people
- Affect rural areas in the developing world
- More than 1 billion people infected
- Transmission cycles perpetuated by
  - environmental contamination
  - poor standards of living



# NTDs

---

- A group of bacterial and parasitic infections endemic in tropical climates
- Some of the most common infections among the world's poorest people
- Affect rural areas in the developing world
- More than 1 billion people infected
- Transmission cycles perpetuated by
  - environmental contamination
  - poor standards of living
  - lack of hygiene.



# The diseases

---

---

<b>Infection</b>	<b>Global prevalence (millions)</b>	<b>Population at risk</b>
------------------	---	---------------------------

# The diseases

Infection		Global prevalence (millions)	Population at risk
<i>Soil-transmitted helminths</i>	Hookworm	807	4.2 billion
	Roundworm	604	3.2 billion
	Whipworm	576	3.2 billion

# The diseases

Infection		Global prevalence (millions)	Population at risk
<i>Soil-transmitted helminths</i>	Hookworm	807	4.2 billion
	Roundworm	604	3.2 billion
	Whipworm	576	3.2 billion
Schistosomiasis		207	779 million
Elephantitis		120	1.3 billion
Trachoma		84	590 million
River blindness		37	90 million

# The diseases

Infection		Global prevalence (millions)	Population at risk
<i>Soil-transmitted helminths</i>	Hookworm	807	4.2 billion
	Roundworm	604	3.2 billion
	Whipworm	576	3.2 billion
Schistosomiasis		207	779 million
Elephantitis		120	1.3 billion
Trachoma		84	590 million
River blindness		37	90 million
Leishmaniasis		12	350 million
Chagas' Disease		8-9	25 million
Leprosy		0.4	N/A
Sleeping sickness		0.3	60 million

# The diseases

Infection		Global prevalence (millions)	Population at risk
<i>Soil-transmitted helminths</i>	Hookworm	807	4.2 billion
	Roundworm	604	3.2 billion
	Whipworm	576	3.2 billion
Schistosomiasis		207	779 million
Elephantitis		120	1.3 billion
Trachoma		84	590 million
River blindness		37	90 million
Leishmaniasis		12	350 million
Chagas' Disease		8-9	25 million
Leprosy		0.4	N/A
Sleeping sickness		0.3	60 million
Guinea Worm Disease		0.01	N/A
Buruli ulcer		N/A	N/A.

# Neglect

---

- These diseases are neglected at the

# Neglect

---

- These diseases are neglected at the
  - community

# Neglect

---

- These diseases are neglected at the
  - community
  - national

# Neglect

---

- These diseases are neglected at the
  - community
  - national
  - international levels

# Neglect

---

- These diseases are neglected at the
  - community
  - national
  - international levels
- Attention to disease in endemic areas usually focuses on

# Neglect

---

- These diseases are neglected at the
  - community
  - national
  - international levels
- Attention to disease in endemic areas usually focuses on
  - HIV/AIDS



# Neglect

---

- These diseases are neglected at the
  - community
  - national
  - international levels
- Attention to disease in endemic areas usually focuses on
  - HIV/AIDS
  - malaria



# Neglect

---

- These diseases are neglected at the
  - community
  - national
  - international levels
- Attention to disease in endemic areas usually focuses on
  - HIV/AIDS
  - malaria
  - TB



# Neglect

---

- These diseases are neglected at the
  - community
  - national
  - international levels
- Attention to disease in endemic areas usually focuses on
  - HIV/AIDS
  - malaria
  - TB

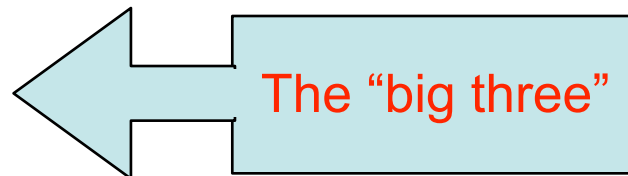

# Neglect

---

- These diseases are neglected at the
  - community
  - national
  - international levels
- Attention to disease in endemic areas usually focuses on
  - HIV/AIDS
  - malaria
  - TB
  - novel emerging infections.

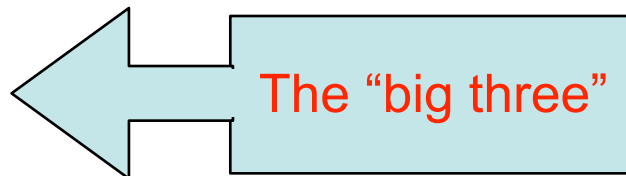

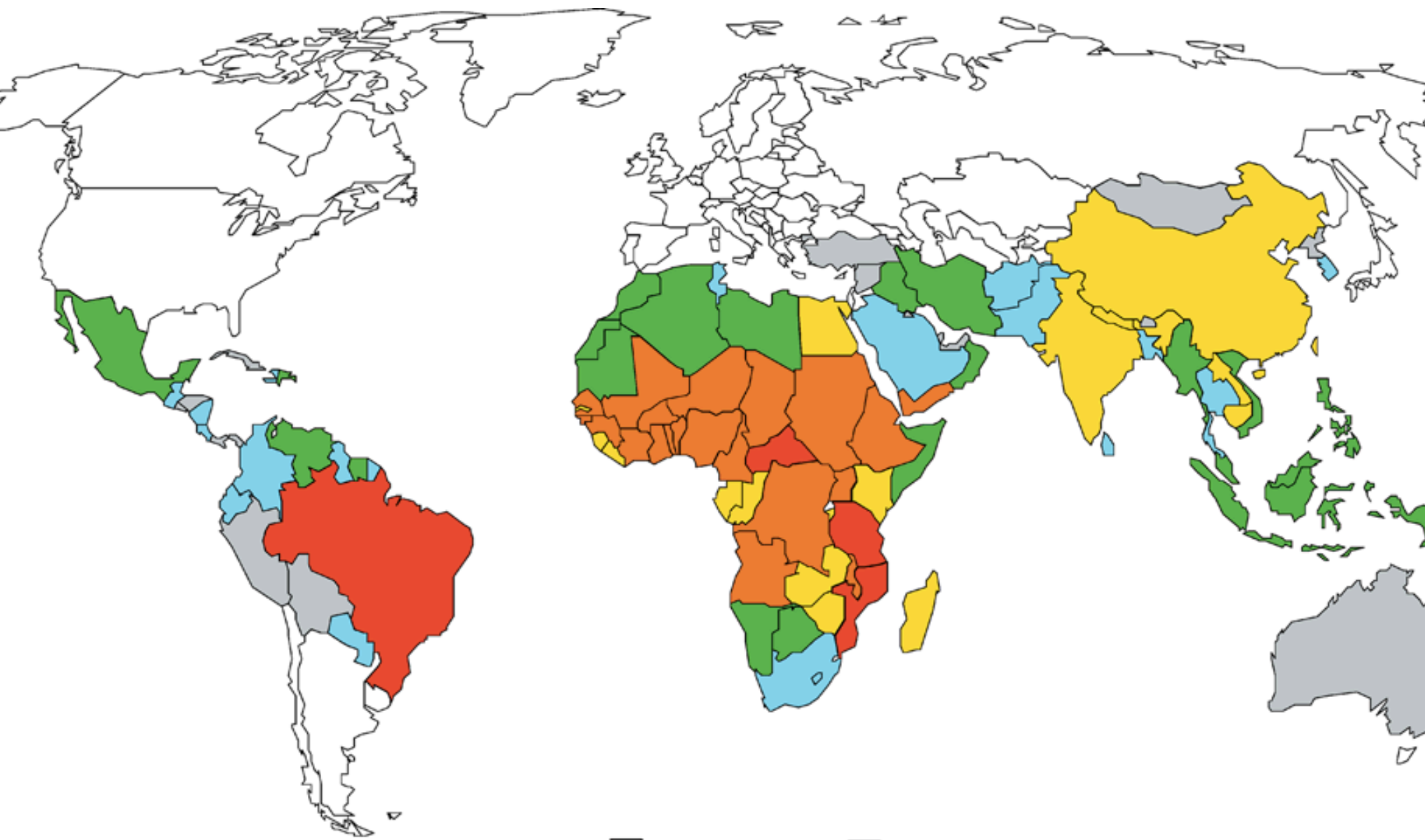

# Common features

---

- Ancient

# Common features

---

- Ancient
- Chronic

# Common features

---

- Ancient
- Chronic
- Disfigurement and disability

# Common features

---

- Ancient
- Chronic
- Disfigurement and disability
- Impair growth and development in children

# Common features

---

- Ancient
- Chronic
- Disfigurement and disability
- Impair growth and development in children
- Large socioeconomic effect

# Common features

---

- Ancient
- Chronic
- Disfigurement and disability
- Impair growth and development in children
- Large socioeconomic effect
- Poverty promoting

# Common features

---

- Ancient
- Chronic
- Disfigurement and disability
- Impair growth and development in children
- Large socioeconomic effect
- Poverty promoting
- Reduce economic productivity

# Common features

---

- Ancient
- Chronic
- Disfigurement and disability
- Impair growth and development in children
- Large socioeconomic effect
- Poverty promoting
- Reduce economic productivity
- Stigmatising

# Common features

---

- Ancient
- Chronic
- Disfigurement and disability
- Impair growth and development in children
- Large socioeconomic effect
- Poverty promoting
- Reduce economic productivity
- Stigmatising
- High disease burden, low mortality

# Common features

---

- Ancient
- Chronic
- Disfigurement and disability
- Impair growth and development in children
- Large socioeconomic effect
- Poverty promoting
- Reduce economic productivity
- Stigmatising
- High disease burden, low mortality (530,000 per year).

# Measuring the impact

---

- DALYs (Disability-Adjusted Life Years)

# Measuring the impact

---

- DALYs (Disability-Adjusted Life Years)
  - measure the number years of life lost from premature death/  
disability

# Measuring the impact

---

- DALYs (Disability-Adjusted Life Years)
  - measure the number years of life lost from premature death/disability

<b>Infection</b>	<b># of DALYs/ year (millions)</b>
------------------	--

# Measuring the impact

---

- DALYs (Disability-Adjusted Life Years)
  - measure the number years of life lost from premature death/disability

Infection	# of DALYs/ year (millions)
HIV/AIDS	84.5

# Measuring the impact

---

- DALYs (Disability-Adjusted Life Years)
  - measure the number years of life lost from premature death/disability

Infection	# of DALYs/ year (millions)
HIV/AIDS	84.5
<b>NTDs</b>	<b>56.6</b>

# Measuring the impact

---

- DALYs (Disability-Adjusted Life Years)
  - measure the number years of life lost from premature death/disability

Infection	# of DALYs/ year (millions)
HIV/AIDS	84.5
<b>NTDs</b>	<b>56.6</b>
Malaria	46.5

# Measuring the impact

---

- DALYs (Disability-Adjusted Life Years)
  - measure the number years of life lost from premature death/disability

Infection	# of DALYs/ year (millions)
HIV/AIDS	84.5
<b>NTDs</b>	<b>56.6</b>
Malaria	46.5
TB	34.7

# Measuring the impact

---

- DALYs (Disability-Adjusted Life Years)
  - measure the number years of life lost from premature death/disability
- These are likely underestimates, especially for NTDs.

Infection	# of DALYs/year (millions)
HIV/AIDS	84.5
<b>NTDs</b>	<b>56.6</b>
Malaria	46.5
TB	34.7

# Proportion of DALYs

---

---

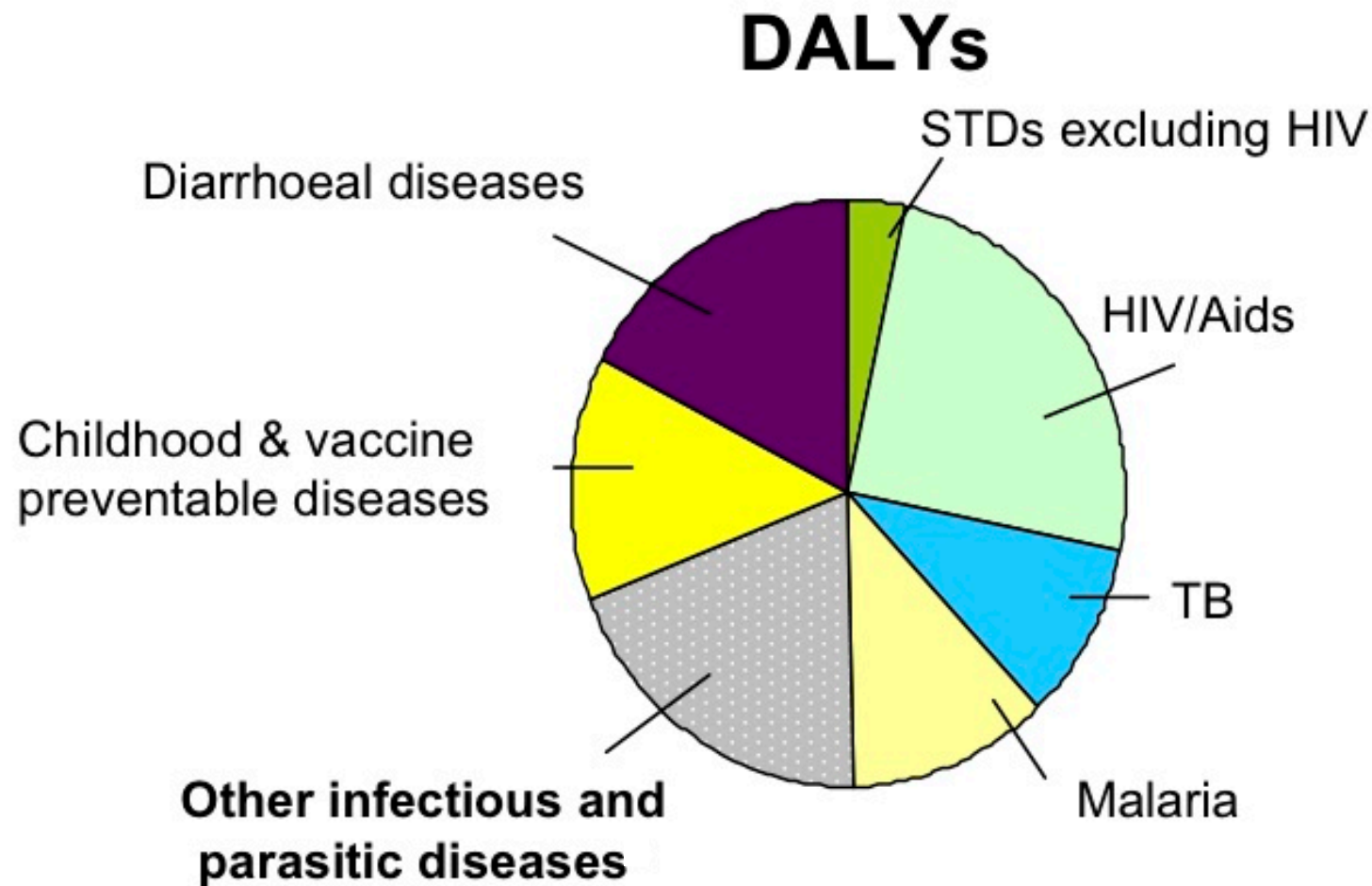

# Proportion of DALYs

---

---

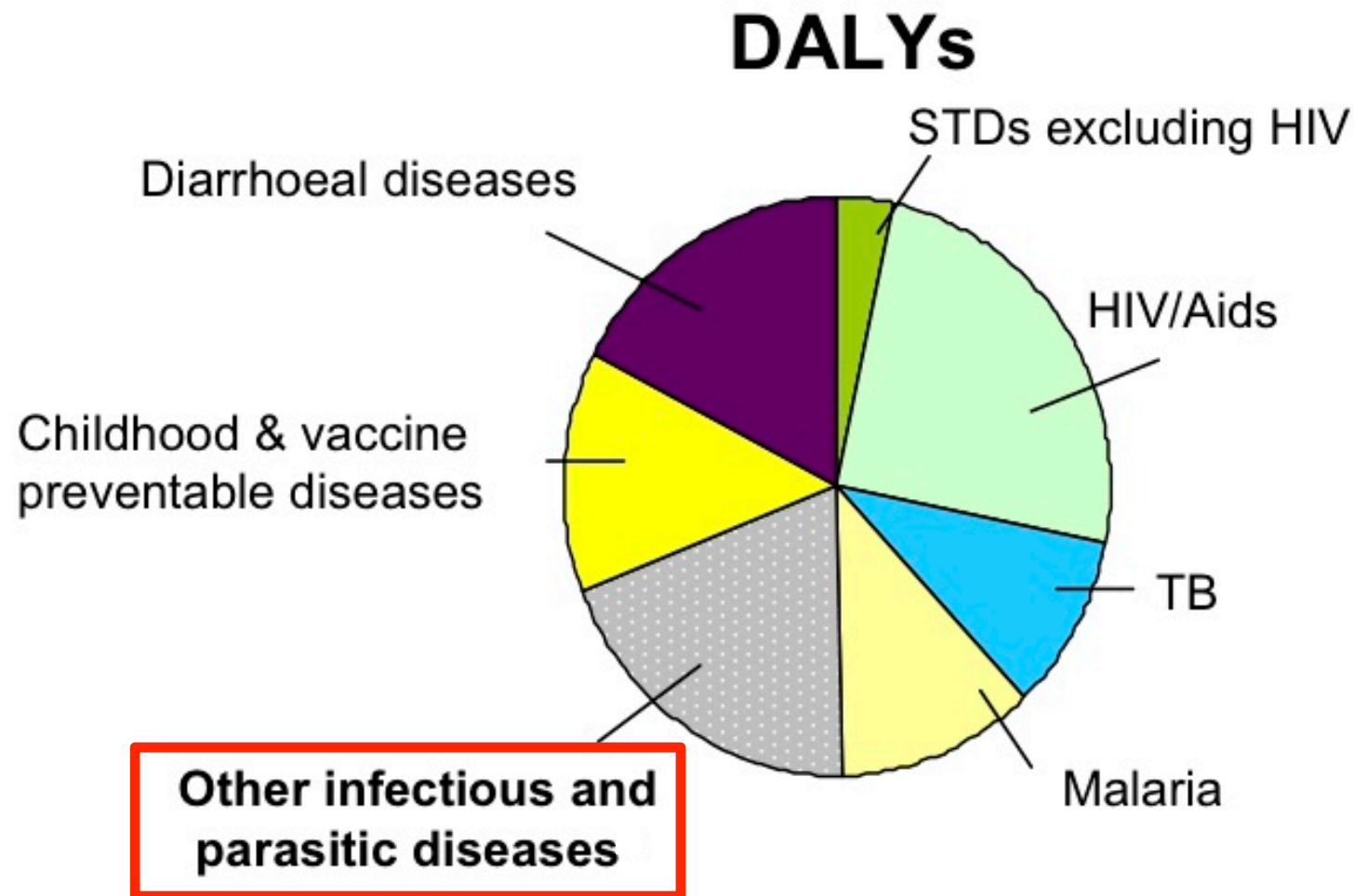

# Categories

---

- Core group of 13 tropical infections

# Categories

---

- Core group of 13 tropical infections
- Helminths

# Categories

---

- Core group of 13 tropical infections
- Helminths
  - Soil-transmitted helminths, elephantitis, river blindness, Guinea worm disease, schistosomiasis

# Categories

---

- Core group of 13 tropical infections
- Helminths
  - Soil-transmitted helminths, elephantitis, river blindness, Guinea worm disease, schistosomiasis
- Protozoan

# Categories

---

- Core group of 13 tropical infections
- Helminths
  - Soil-transmitted helminths, elephantitis, river blindness, Guinea worm disease, schistosomiasis
- Protozoan
  - Leishmaniasis, Chagas' disease, sleeping sickness

# Categories

---

- Core group of 13 tropical infections
- Helminths
  - Soil-transmitted helminths, elephantitis, river blindness, Guinea worm disease, schistosomiasis
- Protozoan
  - Leishmaniasis, Chagas' disease, sleeping sickness
- Bacterial

# Categories

---

- Core group of 13 tropical infections
- Helminths
  - Soil-transmitted helminths, elephantitis, river blindness, Guinea worm disease, schistosomiasis
- Protozoan
  - Leishmaniasis, Chagas' disease, sleeping sickness
- Bacterial
  - Leprosy, trachoma, Buruli ulcer

# Categories

---

- Core group of 13 tropical infections
- Helminths
  - Soil-transmitted helminths, elephantitis, river blindness, Guinea worm disease, schistosomiasis
- Protozoan
  - Leishmaniasis, Chagas' disease, sleeping sickness
- Bacterial
  - Leprosy, trachoma, Buruli ulcer
- Others.

# Soil-transmitted helminths

---

---

<b>Disease</b>	Roundworm	Whipworm	Hookworm
----------------	-----------	----------	----------

# Soil-transmitted helminths

---



<b>Disease</b>	Roundworm	Whipworm	Hookworm
<b>Target</b>	Small intestine	Large intestine (colon)	Small intestine

# Soil-transmitted helminths



---

<b>Disease</b>	Roundworm	Whipworm	Hookworm
<b>Target</b>	Small intestine	Large intestine (colon)	Small intestine
<b>Transmission</b>	Contact with soil contaminated by larva or eggs		



# Soil-transmitted helminths

Disease	Roundworm	Whipworm	Hookworm
Target	Small intestine	Large intestine (colon)	Small intestine
Transmission	Contact with soil contaminated by larva or eggs		
Clinical manifestation/impairment	Anemia: impairs growth and development in children		
	Intestinal obstruction	Inflammation, dystentry	Iron deficiency, malnutrition
	 <p><small>Ascaris lumbricoides roundworms - post-surgery in resected bowel _Image by Dr. Vikas Arora, India</small></p>		

# Soil-transmitted helminths

Disease	Roundworm	Whipworm	Hookworm
Target	Small intestine	Large intestine (colon)	Small intestine
Transmission	Contact with soil contaminated by larva or eggs		
Clinical manifestation/impairment	Anemia: impairs growth and development in children		
	Intestinal obstruction	Inflammation, dystentry	Iron deficiency, malnutrition
	 <small>Ascaris lumbricoides roundworms - post-surgery in resected bowel _Image by Dr. Vikas Arora, India</small>		
Treatment	Benzimidazole anthelmintics		

# Soil-transmitted helminths

Disease	Roundworm	Whipworm	Hookworm
Target	Small intestine	Large intestine (colon)	Small intestine
Transmission	Contact with soil contaminated by larva or eggs		
Clinical manifestation/impairment	Anemia: impairs growth and development in children		
	Intestinal obstruction	Inflammation, dystentry	Iron deficiency, malnutrition
	 <small>Ascaris lumbricoides roundworms - post-surgery in resected bowel _Image by Dr. Vikas Arora, India</small>		
Treatment	Benzimidazole anthelmintics		
Control	Mass dewormings, drugs.		

# Other helminths

---

---

<b>Disease</b>	Elephantitis	River blindness	Guinea worm	Schistosomiasis
----------------	--------------	-----------------	-------------	-----------------

# Other helminths

---

---

<b>Disease</b>	Elephantitis	River blindness	Guinea worm	Schistosomiasis
<b>Target</b>	Lymphatic system, genitals	Subcutaneous tissue	Subcutaneous tissue, legs	Urinary tract, liver, intestines





# Other helminths

---





---

<b>Disease</b>	Elephantitis	River blindness	Guinea worm	Schistosomiasis
<b>Target</b>	Lymphatic system, genitals	Subcutaneous tissue	Subcutaneous tissue, legs	Urinary tract, liver, intestines
<b>Transmission</b>	Mosquitoes	Blackflies	Water fleas in drinking water	Larvae in freshwater





# Other helminths

Disease	Elephantitis	River blindness	Guinea worm	Schistosomiasis
Target	Lymphatic system, genitals	Subcutaneous tissue	Subcutaneous tissue, legs	Urinary tract, liver, intestines
Transmission	Mosquitoes	Blackflies	Water fleas in drinking water	Larvae in freshwater
Clinical manifestation/impairment	Filarial fever, swelling, disfigurement	Malnutrition, developmental/educational impairment		
		Blindness, disfigurement, skin disease	Painful blister in foot, inflammation	Target organ damage, highest mortality
				

# Other helminths

Disease	Elephantitis	River blindness	Guinea worm	Schistosomiasis
Target	Lymphatic system, genitals	Subcutaneous tissue	Subcutaneous tissue, legs	Urinary tract, liver, intestines
Transmission	Mosquitoes	Blackflies	Water fleas in drinking water	Larvae in freshwater
Clinical manifestation/impairment	Filarial fever, swelling, disfigurement	Malnutrition, developmental/educational impairment		
		Blindness, disfigurement, skin disease	Painful blister in foot, inflammation	Target organ damage, highest mortality
				
Treatment	Diethylcarbama-zine, ivermectin, albendazole	Ivermectin	Extract worm on stick	Praziquantel

# Other helminths

Disease	Elephantitis	River blindness	Guinea worm	Schistosomiasis
Target	Lymphatic system, genitals	Subcutaneous tissue	Subcutaneous tissue, legs	Urinary tract, liver, intestines
Transmission	Mosquitoes	Blackflies	Water fleas in drinking water	Larvae in freshwater
Clinical manifestation/impairment	Filarial fever, swelling, disfigurement	Malnutrition, developmental/educational impairment		
		Blindness, disfigurement, skin disease	Painful blister in foot, inflammation	Target organ damage, highest mortality
				
Treatment	Diethylcarbamazine, ivermectin, albendazole	Ivermectin	Extract worm on stick	Praziquantel
Control	Interrupt transmission cycle, yearly mass drug admin	Vector control, yearly mass drug admin	Safe water, health education	Molluscicide, yearly mass drug admin.

# Protozoans

---

<b>Disease</b>	Leishmaniasis		Chagas' Disease	Sleeping sickness	
	<i>Visceral</i>	<i>Cutaneous</i>		<i>T.b.g.</i>	<i>T.b.r.</i>



# Protozoans

Disease	Leishmaniasis		Chagas' Disease	Sleeping sickness	
	<i>Visceral</i>	<i>Cutaneous</i>		<i>T.b.g.</i>	<i>T.b.r.</i>
Target	Liver, spleen, blood, bone marrow	Skin	Multiple	Blood, lymph, spinal fluid, central nervous system	



# Protozoans

Disease	Leishmaniasis		Chagas' Disease	Sleeping sickness	
	<i>Visceral</i>	<i>Cutaneous</i>		<i>T.b.g.</i>	<i>T.b.r.</i>
Target	Liver, spleen, blood, bone marrow	Skin	Multiple	Blood, lymph, spinal fluid, central nervous system	
Transmission	Sandflies		Triatome bugs	Tsetse flies	



# Protozoans

Disease	Leishmaniasis		Chagas' Disease	Sleeping sickness	
	<i>Visceral</i>	<i>Cutaneous</i>		<i>T.b.g.</i>	<i>T.b.r.</i>
Target	Liver, spleen, blood, bone marrow	Skin	Multiple	Blood, lymph, spinal fluid, central nervous system	
Transmission	Sandflies		Triatome bugs	Tsetse flies	
Clinical manifestation/impairment	Decreased red blood cell count, fever, weight loss	Disfigurement	Chronic heart disease, megacolon, megaesophagus	Coma & death	
					

# Protozoans

Disease	Leishmaniasis		Chagas' Disease	Sleeping sickness	
	<i>Visceral</i>	<i>Cutaneous</i>		<i>T.b.g.</i>	<i>T.b.r.</i>
Target	Liver, spleen, blood, bone marrow	Skin	Multiple	Blood, lymph, spinal fluid, central nervous system	
Transmission	Sandflies		Triatome bugs	Tsetse flies	
Clinical manifestation/impairment	Decreased red blood cell count, fever, weight loss	Disfigurement	Chronic heart disease, megacolon, megaesophagus	Coma & death	
					
Treatment	Amphotericin B, Pentamidine, Mitefosine		Nifurtimox, Benznidazole, Pacemakers/transplant	Pentadmine, Suramine, Melarsoprol, Eflornithine	

# Protozoans

Disease	Leishmaniasis		Chagas' Disease	Sleeping sickness	
	Visceral	Cutaneous		T.b.g.	T.b.r.
Target	Liver, spleen, blood, bone marrow	Skin	Multiple	Blood, lymph, spinal fluid, central nervous system	
Transmission	Sandflies		Triatome bugs	Tsetse flies	
Clinical manifestation/impairment	Decreased red blood cell count, fever, weight loss	Disfigurement	Chronic heart disease, megacolon, megaesophagus	Coma & death	
					
Treatment	Amphotericin B, Pentamidine, Mitefosine		Nifurtimox, Benznidazole, Pacemakers/transplant	Pentadmine, Suramine, Melarsoprol, Eflornithine	
Control	Case detection & management, vector control		Case detection & management, vector control	Case detection & management.	

# Bacterial

---

---

<b>Disease</b>	Buruli ulcer	Leprosy	Trachoma
----------------	--------------	---------	----------





# Bacterial

---

---

<b>Disease</b>	Buruli ulcer	Leprosy	Trachoma
<b>Transmission</b>	Unknown	Unknown	Direct contact with discharge

# Bacterial

Disease	Buruli ulcer	Leprosy		Trachoma
Transmission	Unknown	Unknown		Direct contact with discharge
Clinical manifestation/impairment	Disfiguring skin infection, amputation	<i>Tuberculoid</i>	<i>Lepromatous</i>	Irreversible visual impairment, blindness
		Loss of sensation, skin lesions	Disfigurement, bone invasion	
				

# Bacterial

Disease	Buruli ulcer	Leprosy		Trachoma
Transmission	Unknown	Unknown		Direct contact with discharge
Clinical manifestation/impairment	Disfiguring skin infection, amputation	<i>Tuberculoid</i>	<i>Lepromatous</i>	Irreversible visual impairment, blindness
		Loss of sensation, skin lesions	Disfigurement, bone invasion	
Treatment	Rifamprin, streptomycin, debridement/graft	Dapsone, rifamprin, clofazimime		Azithromycin



# Bacterial

Disease	Buruli ulcer	Leprosy		Trachoma
Transmission	Unknown	Unknown		Direct contact with discharge
Clinical manifestation/impairment	Disfiguring skin infection, amputation	<i>Tuberculoid</i>	<i>Lepromatous</i>	Irreversible visual impairment, blindness
		Loss of sensation, skin lesions	Disfigurement, bone invasion	
Treatment	Rifamprin, streptomycin, debridement/graft	Dapsone, rifamprin, clofazimime		Azithromycin
Control	Amputation	Multidrug treatment		facial hygiene, surgery



# Management and control

---

- Prevention/treatment exists for most NTDs

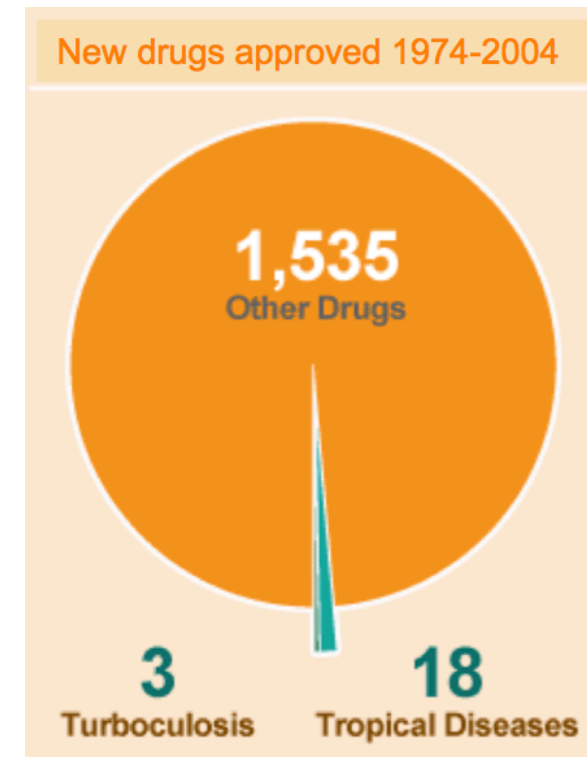

# Management and control

---

- Prevention/treatment exists for most NTDs
  - cheap and effective chemical pharmaceuticals are available for some NTDs

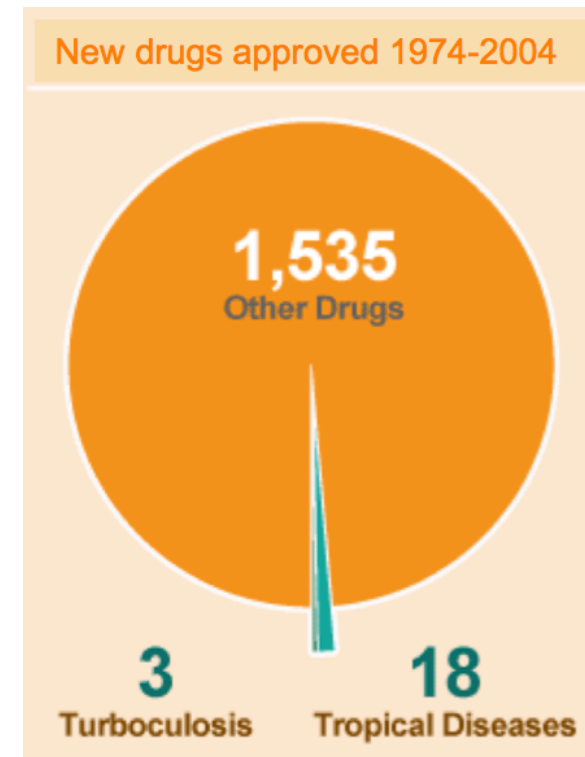

# Management and control

---

- Prevention/treatment exists for most NTDs
  - cheap and effective chemical pharmaceuticals are available for some NTDs
- Not available to the people at risk

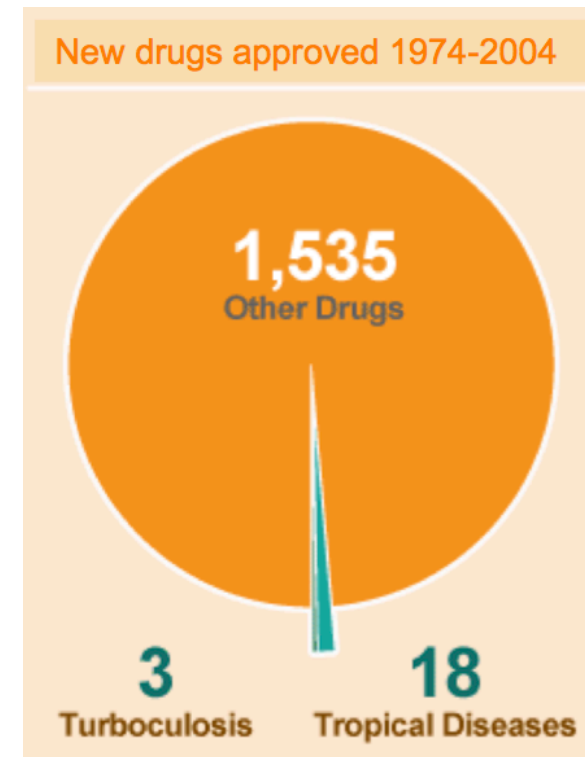

# Management and control

---

- Prevention/treatment exists for most NTDs
  - cheap and effective chemical pharmaceuticals are available for some NTDs
- Not available to the people at risk
  - access and distribution difficulties

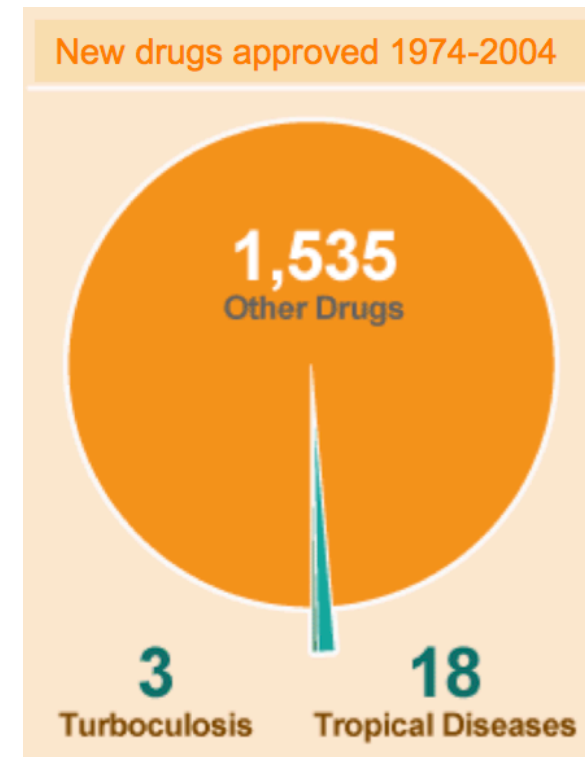

# Management and control

---

- Prevention/treatment exists for most NTDs
  - cheap and effective chemical pharmaceuticals are available for some NTDs
- Not available to the people at risk
  - access and distribution difficulties
- Lack of healthcare infrastructure

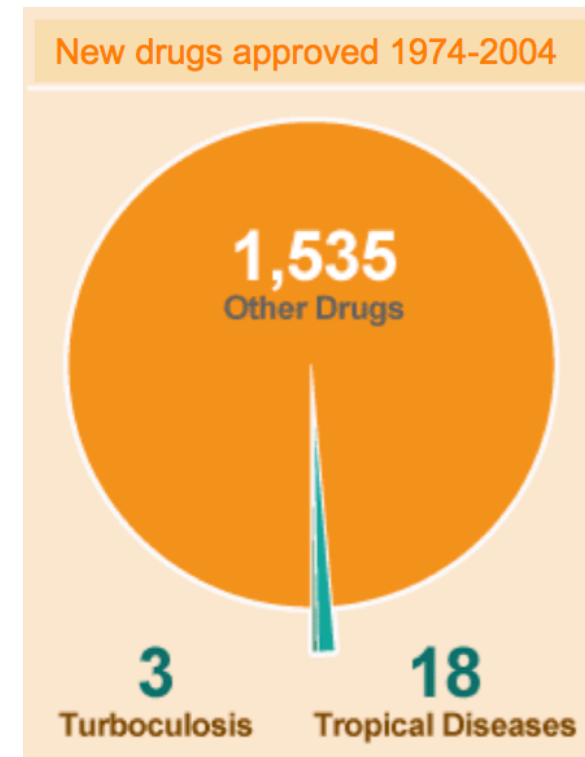

# Management and control

---

- Prevention/treatment exists for most NTDs
  - cheap and effective chemical pharmaceuticals are available for some NTDs
- Not available to the people at risk
  - access and distribution difficulties
- Lack of healthcare infrastructure
  - lack of R&D for existing and novel pharmaceuticals

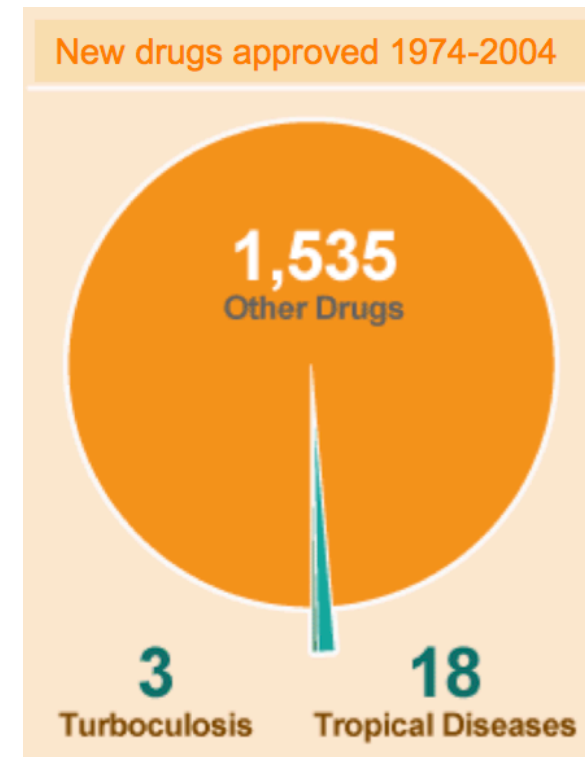

# Management and control

---

- Prevention/treatment exists for most NTDs
  - cheap and effective chemical pharmaceuticals are available for some NTDs
- Not available to the people at risk
  - access and distribution difficulties
- Lack of healthcare infrastructure
  - lack of R&D for existing and novel pharmaceuticals
  - treatments may be toxic

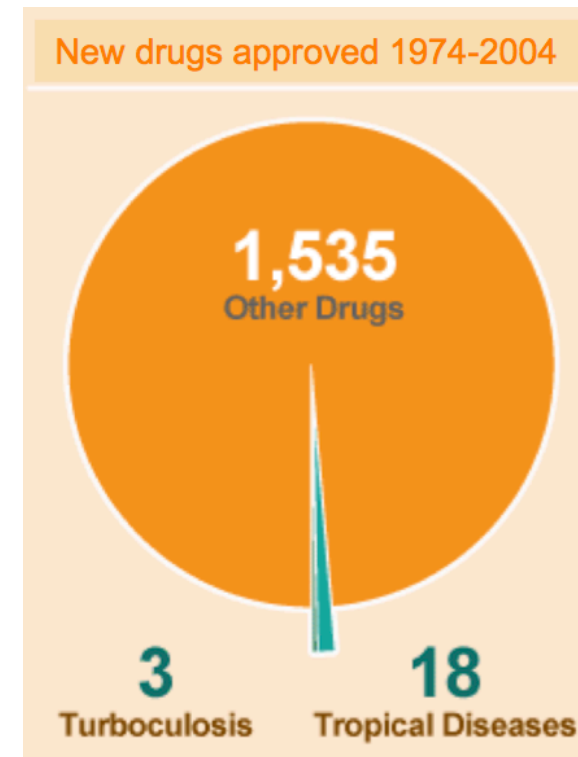

# Management and control

---

- Prevention/treatment exists for most NTDs
  - cheap and effective chemical pharmaceuticals are available for some NTDs
- Not available to the people at risk
  - access and distribution difficulties
- Lack of healthcare infrastructure
  - lack of R&D for existing and novel pharmaceuticals
  - treatments may be toxic
- Inadequate funding.

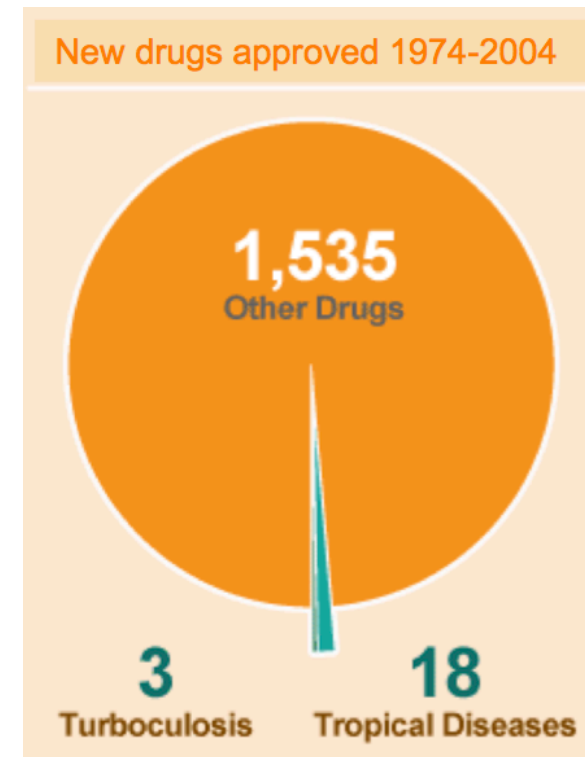

# What can help

---

- Availability and access to health care



# What can help

---

- Availability and access to health care
- Clean living conditions



# What can help

---

- Availability and access to health care
- Clean living conditions
- Clean drinking water



# What can help

---

- Availability and access to health care
- Clean living conditions
- Clean drinking water
- Adequate nutrition



# What can help

---

- Availability and access to health care
- Clean living conditions
- Clean drinking water
- Adequate nutrition
- Education



# What can help

---

- Availability and access to health care
- Clean living conditions
- Clean drinking water
- Adequate nutrition
- Education
- Gender equality



# What can help

---

- Availability and access to health care
- Clean living conditions
- Clean drinking water
- Adequate nutrition
- Education
- Gender equality
- Non-discrimination



# What can help

---

- Availability and access to health care
- Clean living conditions
- Clean drinking water
- Adequate nutrition
- Education
- Gender equality
- Non-discrimination
- Pharmaceutical research and development



# What can help

---

- Availability and access to health care
- Clean living conditions
- Clean drinking water
- Adequate nutrition
- Education
- Gender equality
- Non-discrimination
- Pharmaceutical research and development
- Overhaul of drug patent systems



# What can help

---

- Availability and access to health care
- Clean living conditions
- Clean drinking water
- Adequate nutrition
- Education
- Gender equality
- Non-discrimination
- Pharmaceutical research and development
- Overhaul of drug patent systems
- Identification/targeting of vulnerable groups.



# Organisation

---

- Public-private partnerships have had considerable success

# Organisation

- Public-private partnerships have had considerable success
- Eg Guinea worm disease has been almost entirely eradicated, despite no biomedical intervention

## GUINEA WORM ERADICATION PROGRESS

Declines in total number of cases since 1989

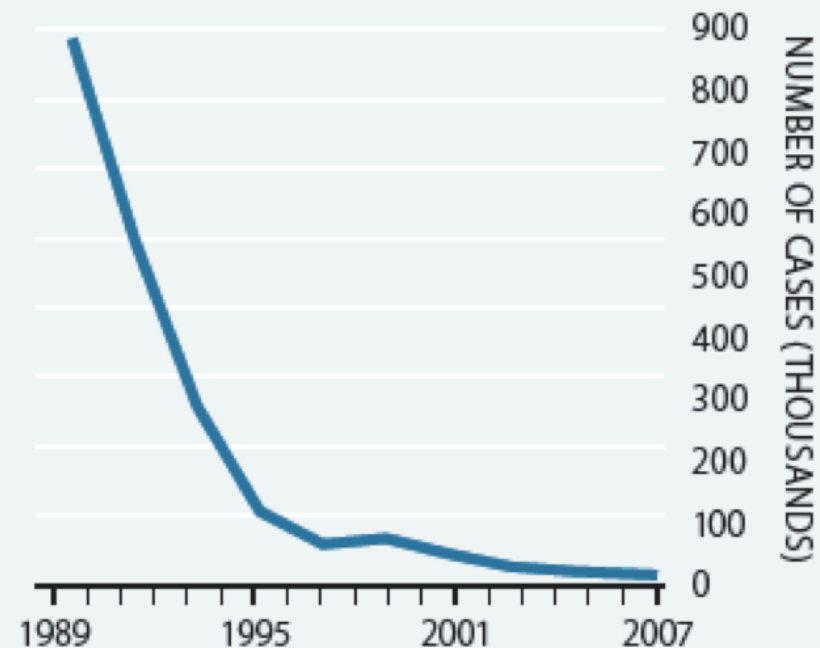

Source: World Health Organization

# Organisation

- Public-private partnerships have had considerable success
- Eg Guinea worm disease has been almost entirely eradicated, despite no biomedical intervention
- These relationships need to be strengthened.

## GUINEA WORM ERADICATION PROGRESS

Declines in total number of cases since 1989

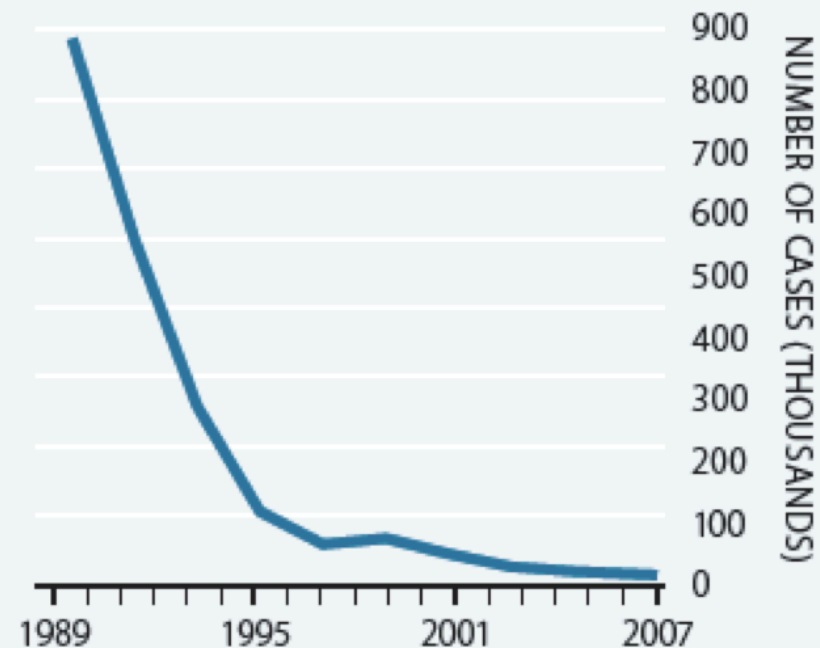

Source: World Health Organization

# Mathematical models

- Have contributed to many advances in disease control and management

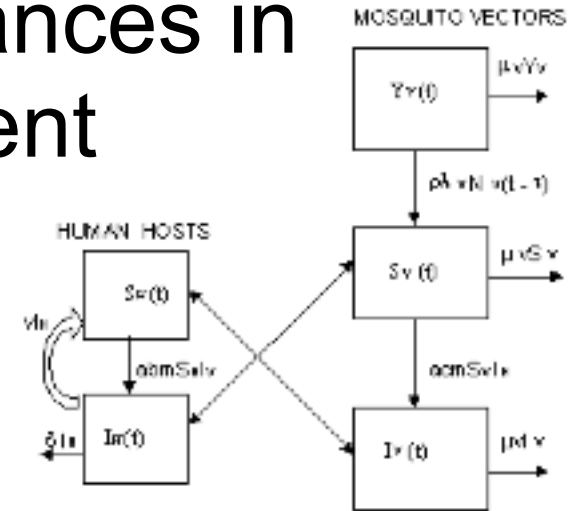

$$\frac{dS_H}{dt} = -abmS_H I_V + \nu I_H$$

$$\frac{dI_H}{dt} = abmS_H I_V - \nu I_H - \delta I_H$$

$$\frac{dY_V}{dt} = \lambda_V N_V(t) - \rho \lambda_V N_V(t - \tau) - \mu_V Y_V$$

$$\frac{dS_V}{dt} = \rho \lambda_V N_V(t - \tau) - acS_V I_H - \mu_V S_V$$

$$\frac{dI_V}{dt} = acS_V I_H - \mu_V I_V$$

# Mathematical models

- Have contributed to many advances in disease control and management
- Eg

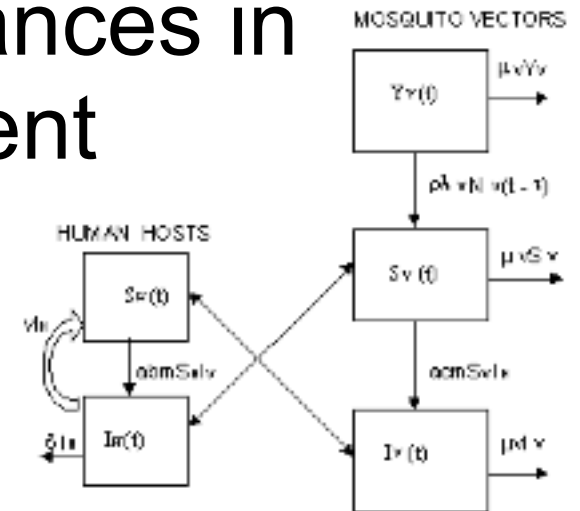

$$\frac{dS_H}{dt} = -abmS_H I_V + \nu I_H$$

$$\frac{dI_H}{dt} = abmS_H I_V - \nu I_H - \delta I_H$$

$$\frac{dY_V}{dt} = \lambda_V N_V(t) - \rho \lambda_V N_V(t - \tau) - \mu_V Y_V$$

$$\frac{dS_V}{dt} = \rho \lambda_V N_V(t - \tau) - acS_V I_H - \mu_V S_V$$

$$\frac{dI_V}{dt} = acS_V I_H - \mu_V I_V$$

# Mathematical models

- Have contributed to many advances in disease control and management
- Eg
  - malaria control

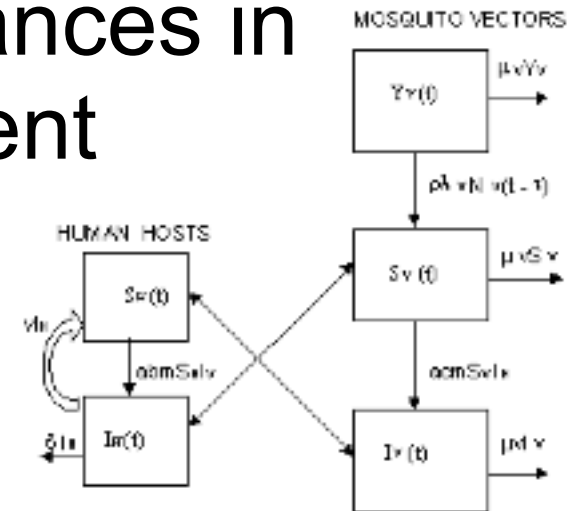

$$\frac{dS_H}{dt} = -abmS_H I_V + \nu I_H$$

$$\frac{dI_H}{dt} = abmS_H I_V - \nu I_H - \delta I_H$$

$$\frac{dY_V}{dt} = \lambda_V N_V(t) - \rho \lambda_V N_V(t - \tau) - \mu_V Y_V$$

$$\frac{dS_V}{dt} = \rho \lambda_V N_V(t - \tau) - acS_V I_H - \mu_V S_V$$

$$\frac{dI_V}{dt} = acS_V I_H - \mu_V I_V$$

# Mathematical models

- Have contributed to many advances in disease control and management
- Eg
  - malaria control
  - smallpox eradication

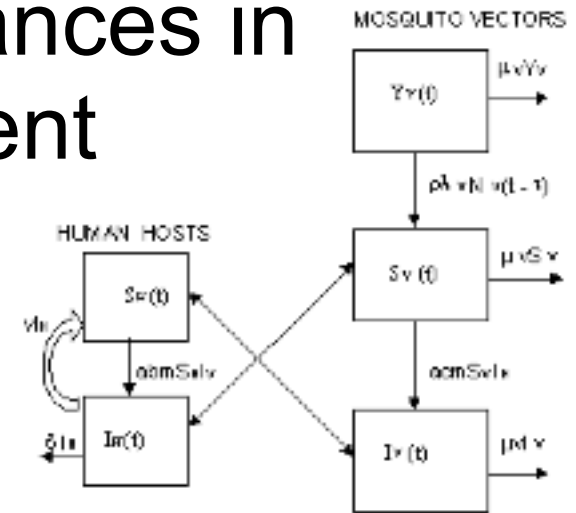

$$\frac{dS_H}{dt} = -abmS_H I_V + \nu I_H$$

$$\frac{dI_H}{dt} = abmS_H I_V - \nu I_H - \delta I_H$$

$$\frac{dY_V}{dt} = \lambda_V N_V(t) - \rho \lambda_V N_V(t - \tau) - \mu_V Y_V$$

$$\frac{dS_V}{dt} = \rho \lambda_V N_V(t - \tau) - acS_V I_H - \mu_V S_V$$

$$\frac{dI_V}{dt} = acS_V I_H - \mu_V I_V$$

# Mathematical models

- Have contributed to many advances in disease control and management
- Eg
  - malaria control
  - smallpox eradication
  - polio eradication

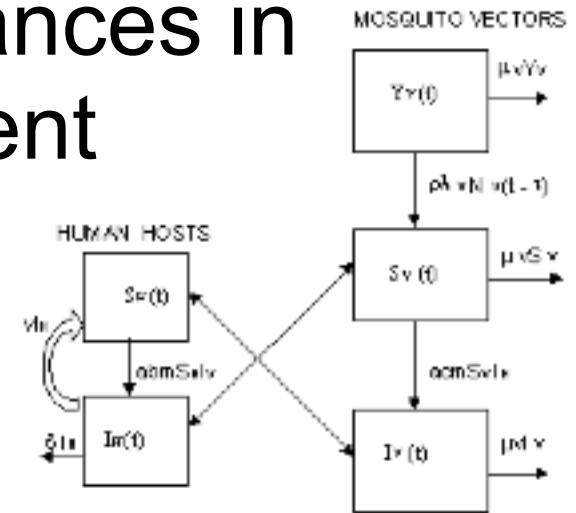

$$\frac{dS_H}{dt} = -abmS_H I_V + \nu I_H$$

$$\frac{dI_H}{dt} = abmS_H I_V - \nu I_H - \delta I_H$$

$$\frac{dY_V}{dt} = \lambda_V N_V(t) - \rho \lambda_V N_V(t - \tau) - \mu_V Y_V$$

$$\frac{dS_V}{dt} = \rho \lambda_V N_V(t - \tau) - acS_V I_H - \mu_V S_V$$

$$\frac{dI_V}{dt} = acS_V I_H - \mu_V I_V$$

# Mathematical models

- Have contributed to many advances in disease control and management
- Eg
  - malaria control
  - smallpox eradication
  - polio eradication
  - vaccine design

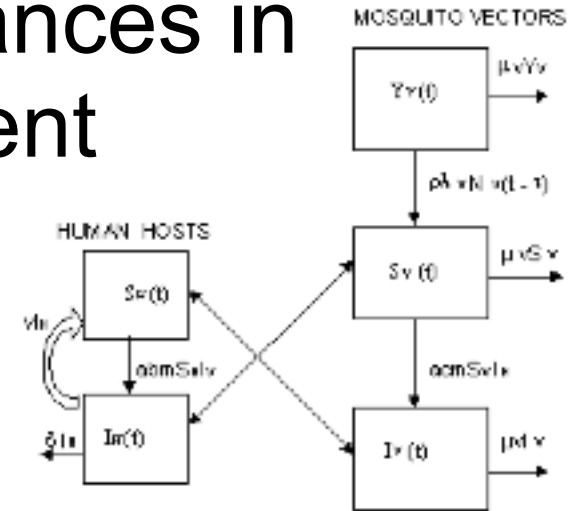

$$\frac{dS_H}{dt} = -abmS_H I_V + \nu I_H$$

$$\frac{dI_H}{dt} = abmS_H I_V - \nu I_H - \delta I_H$$

$$\frac{dY_V}{dt} = \lambda_V N_V(t) - \rho \lambda_V N_V(t - \tau) - \mu_V Y_V$$

$$\frac{dS_V}{dt} = \rho \lambda_V N_V(t - \tau) - acS_V I_H - \mu_V S_V$$

$$\frac{dI_V}{dt} = acS_V I_H - \mu_V I_V$$

# Mathematical models

- Have contributed to many advances in disease control and management
- Eg
  - malaria control
  - smallpox eradication
  - polio eradication
  - vaccine design
  - mosquito management

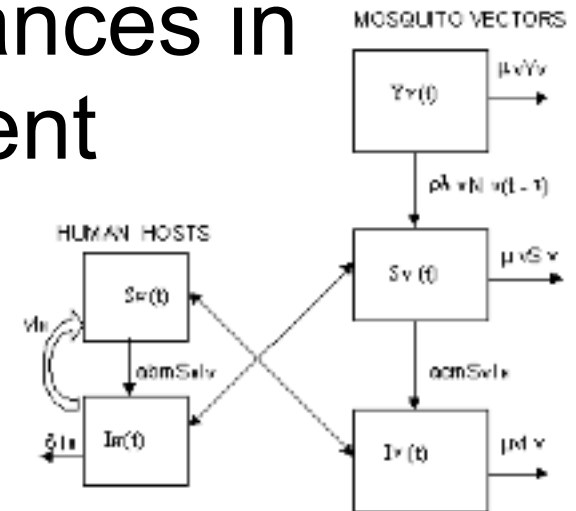

$$\frac{dS_H}{dt} = -abmS_HI_V + \nu I_H$$

$$\frac{dI_H}{dt} = abmS_HI_V - \nu I_H - \delta I_H$$

$$\frac{dY_V}{dt} = \lambda_V N_V(t) - \rho \lambda_V N_V(t - \tau) - \mu_V Y_V$$

$$\frac{dS_V}{dt} = \rho \lambda_V N_V(t - \tau) - acS_VI_H - \mu_V S_V$$

$$\frac{dI_V}{dt} = acS_VI_H - \mu_V I_V$$

# Mathematical models

- Have contributed to many advances in disease control and management
- Eg
  - malaria control
  - smallpox eradication
  - polio eradication
  - vaccine design
  - mosquito management
  - effects of climate change

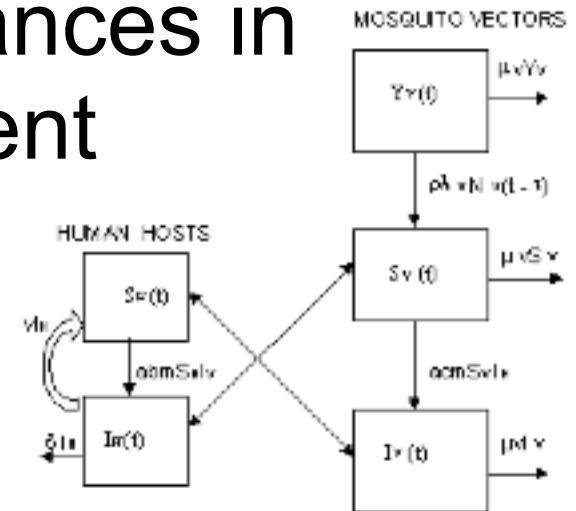

$$\frac{dS_H}{dt} = -abmS_H I_V + \nu I_H$$

$$\frac{dI_H}{dt} = abmS_H I_V - \nu I_H - \delta I_H$$

$$\frac{dY_V}{dt} = \lambda_V N_V(t) - \rho \lambda_V N_V(t - \tau) - \mu_V Y_V$$

$$\frac{dS_V}{dt} = \rho \lambda_V N_V(t - \tau) - acS_V I_H - \mu_V S_V$$

$$\frac{dI_V}{dt} = acS_V I_H - \mu_V I_V$$

# Mathematical models

- Have contributed to many advances in disease control and management
- Eg
  - malaria control
  - smallpox eradication
  - polio eradication
  - vaccine design
  - mosquito management
  - effects of climate change
  - emergency preparedness.

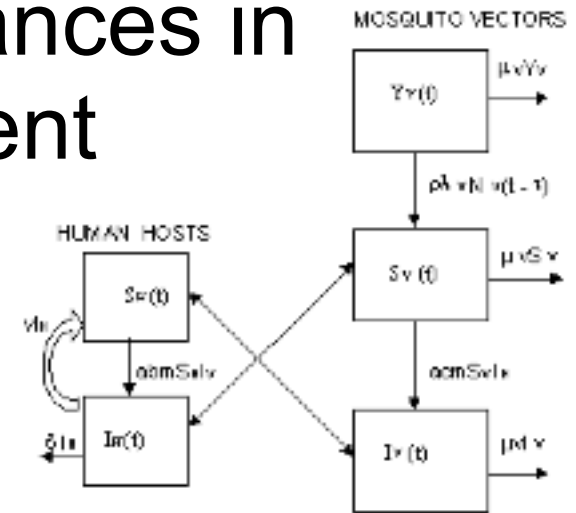

$$\frac{dS_H}{dt} = -abmS_H I_V + \nu I_H$$

$$\frac{dI_H}{dt} = abmS_H I_V - \nu I_H - \delta I_H$$

$$\frac{dY_V}{dt} = \lambda_V N_V(t) - \rho \lambda_V N_V(t - \tau) - \mu_V Y_V$$

$$\frac{dS_V}{dt} = \rho \lambda_V N_V(t - \tau) - acS_V I_H - \mu_V S_V$$

$$\frac{dI_V}{dt} = acS_V I_H - \mu_V I_V$$

# Advantages of models

---

- Can assess theoretical intervention methods in the absence of data



# Advantages of models

---

- Can assess theoretical intervention methods in the absence of data
- Eg



# Advantages of models

---

- Can assess theoretical intervention methods in the absence of data
- Eg
  - optimal drug administration schedule



# Advantages of models

---

- Can assess theoretical intervention methods in the absence of data
- Eg
  - optimal drug administration schedule
  - optimal allocation of limited resources



# Advantages of models

---

- Can assess theoretical intervention methods in the absence of data
- Eg
  - optimal drug administration schedule
  - optimal allocation of limited resources
  - vector control

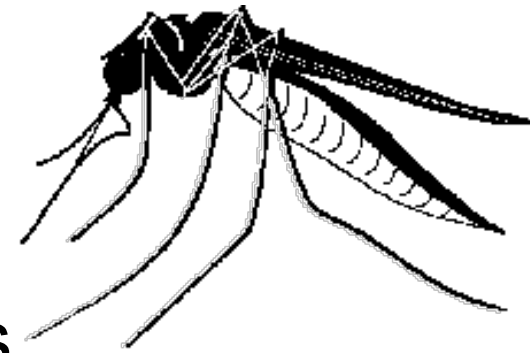

# Advantages of models

---

- Can assess theoretical intervention methods in the absence of data
- Eg
  - optimal drug administration schedule
  - optimal allocation of limited resources
  - vector control
- However, models depend critically on the assumptions used to construct them



# Advantages of models

---

- Can assess theoretical intervention methods in the absence of data
- Eg
  - optimal drug administration schedule
  - optimal allocation of limited resources
  - vector control
- However, models depend critically on the assumptions used to construct them
- Modellers need to be clear about limitations

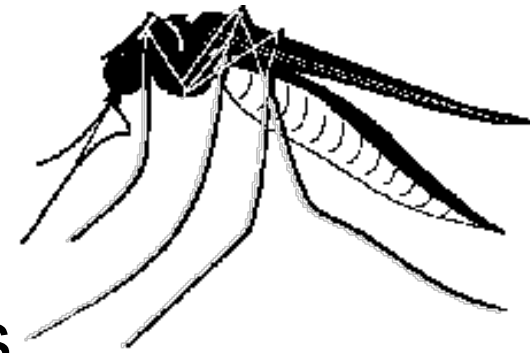

# Advantages of models

---

- Can assess theoretical intervention methods in the absence of data
- Eg
  - optimal drug administration schedule
  - optimal allocation of limited resources
  - vector control
- However, models depend critically on the assumptions used to construct them
- Modellers need to be clear about limitations
- Policy analysts need to be better educated about the power of models.



# Modelling

---

- Provides greater understanding of existing control strategies without costly experiments

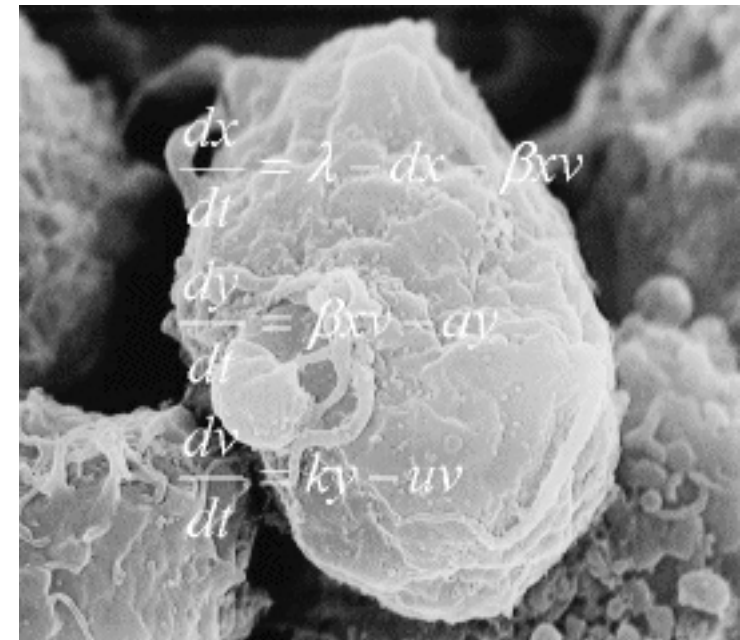

# Modelling

---

- Provides greater understanding of existing control strategies without costly experiments
- Can find control/eradication thresholds

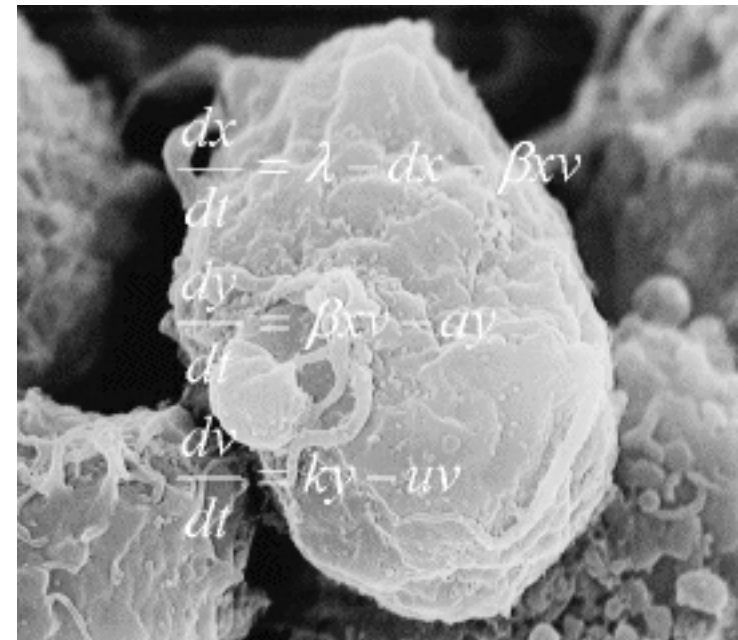

# Modelling

---

- Provides greater understanding of existing control strategies without costly experiments
- Can find control/eradication thresholds
- Limited by

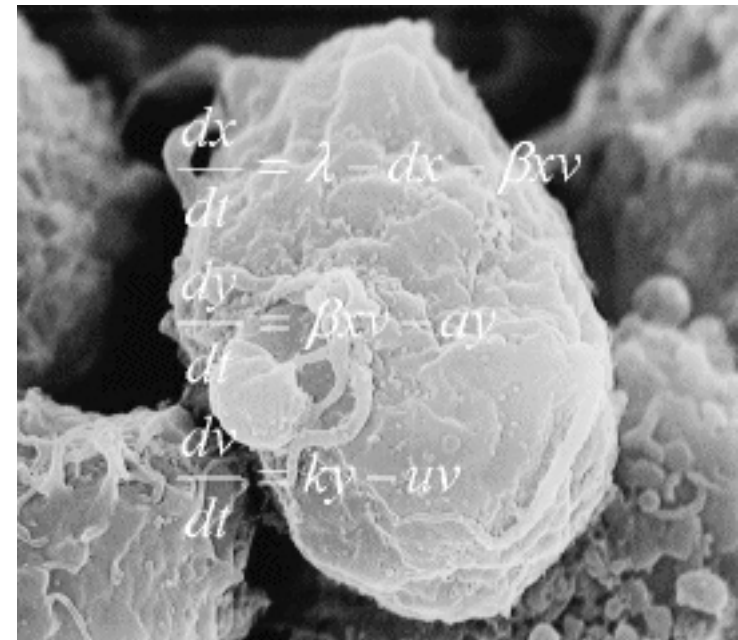

# Modelling

---

- Provides greater understanding of existing control strategies without costly experiments
- Can find control/eradication thresholds
- Limited by
  - lack of access to data

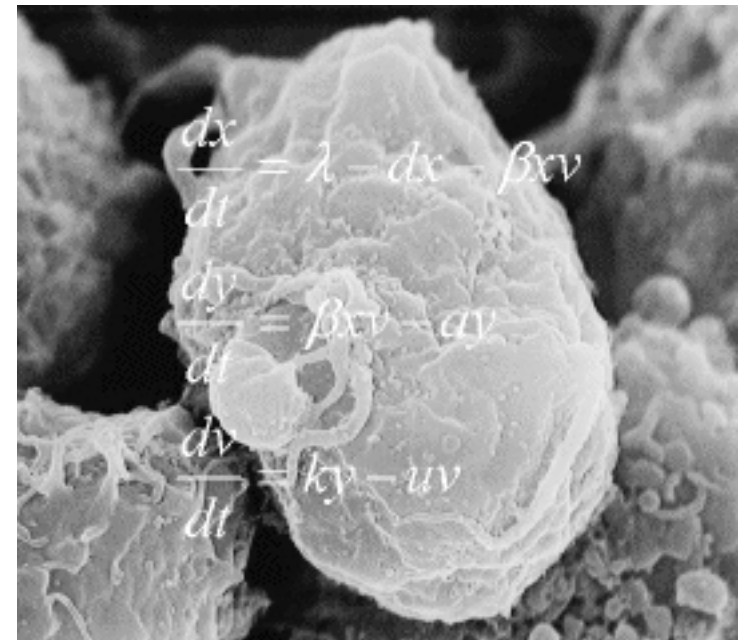

# Modelling

---

- Provides greater understanding of existing control strategies without costly experiments
- Can find control/eradication thresholds
- Limited by
  - lack of access to data
  - disinterest by funding bodies

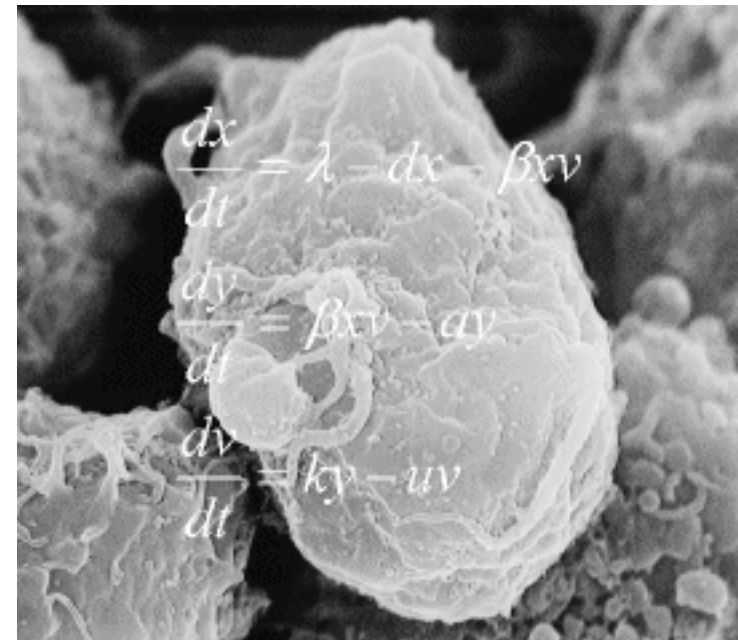

# Modelling

---

- Provides greater understanding of existing control strategies without costly experiments
- Can find control/eradication thresholds
- Limited by
  - lack of access to data
  - disinterest by funding bodies
  - insufficient communication between policy analysts and modellers

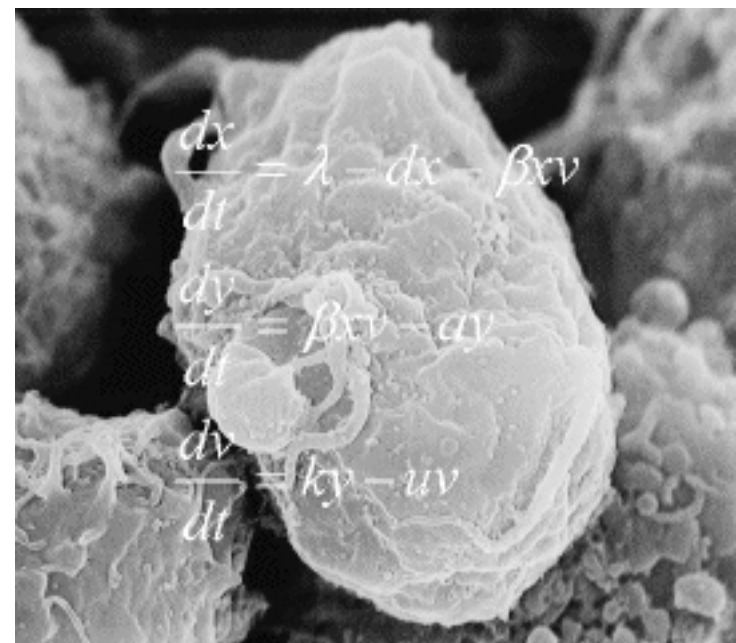

# Modelling

---

- Provides greater understanding of existing control strategies without costly experiments
- Can find control/eradication thresholds
- Limited by
  - lack of access to data
  - disinterest by funding bodies
  - insufficient communication between policy analysts and modellers
  - a reliance on a model's conclusion that does not consider its assumptions.

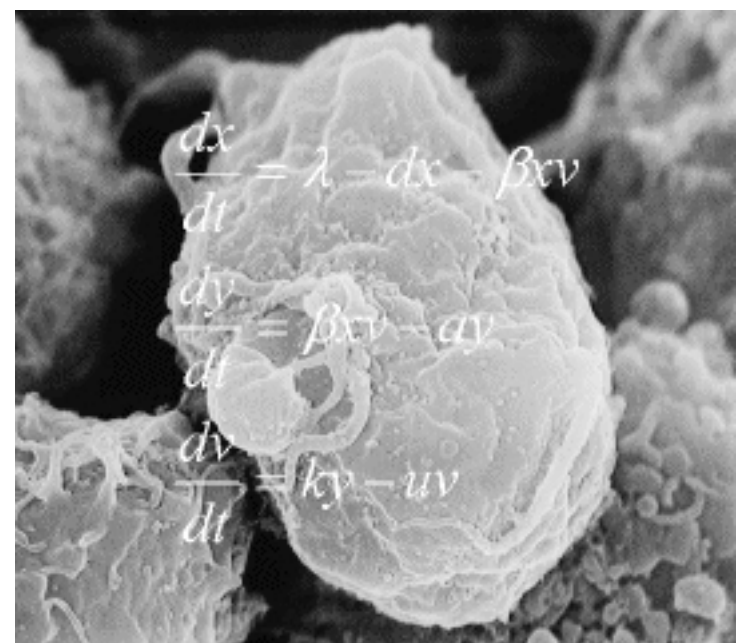

# NTD modelling so far...

---

- Only sleeping sickness has received any substantial theoretical modelling



# NTD modelling so far...

---

- Only sleeping sickness has received any substantial theoretical modelling
- No models for the Buruli ulcer



# NTD modelling so far...

---

- Only sleeping sickness has received any substantial theoretical modelling
- No models for the Buruli ulcer
- Only one for Guinea worm



# NTD modelling so far...

---

- Only sleeping sickness has received any substantial theoretical modelling
- No models for the Buruli ulcer
- Only one for Guinea worm
- Models that do exist are usually limited to one lab and its collaborators per NTD



# NTD modelling so far...

---

- Only sleeping sickness has received any substantial theoretical modelling
- No models for the Buruli ulcer
- Only one for Guinea worm
- Models that do exist are usually limited to one lab and its collaborators per NTD
- A diversity of voices is urgently needed.



# A modelling success story

---

- The West African River Blindness Control Program was hailed as a success due to integrated modelling and control efforts

# A modelling success story

---

- The West African River Blindness Control Program was hailed as a success due to integrated modelling and control efforts
- Modelling predicted that 14 years of vector control would reduce the risk to less than 1%

# A modelling success story

---

- The West African River Blindness Control Program was hailed as a success due to integrated modelling and control efforts
- Modelling predicted that 14 years of vector control would reduce the risk to less than 1%
- Helped convince donors that control was feasible

# A modelling success story

---

- The West African River Blindness Control Program was hailed as a success due to integrated modelling and control efforts
- Modelling predicted that 14 years of vector control would reduce the risk to less than 1%
- Helped convince donors that control was feasible
- Models were refined using subsequent data to include treatment

# A modelling success story

---

- The West African River Blindness Control Program was hailed as a success due to integrated modelling and control efforts
- Modelling predicted that 14 years of vector control would reduce the risk to less than 1%
- Helped convince donors that control was feasible
- Models were refined using subsequent data to include treatment
- Modelling retained a prominent role in subsequent policy discussions.

# Future directions for modelling

---

- More mathematical models are urgently needed

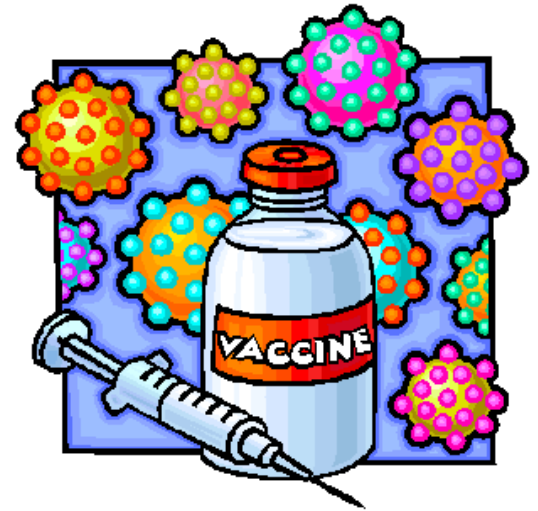

# Future directions for modelling

---

- More mathematical models are urgently needed
- Existing control efforts need to be optimised

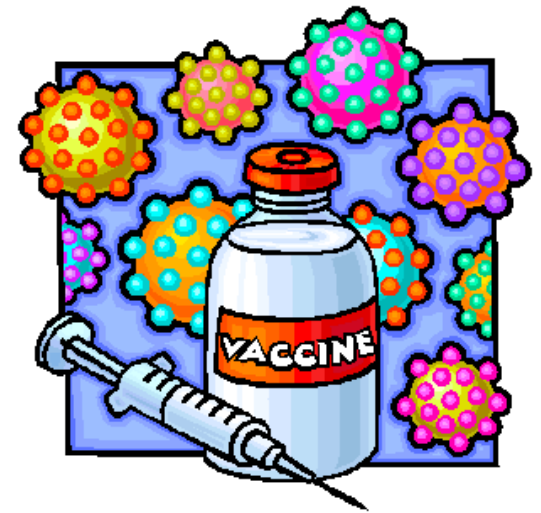

# Future directions for modelling

---

- More mathematical models are urgently needed
- Existing control efforts need to be optimised
- Theoretical interventions need to be examined

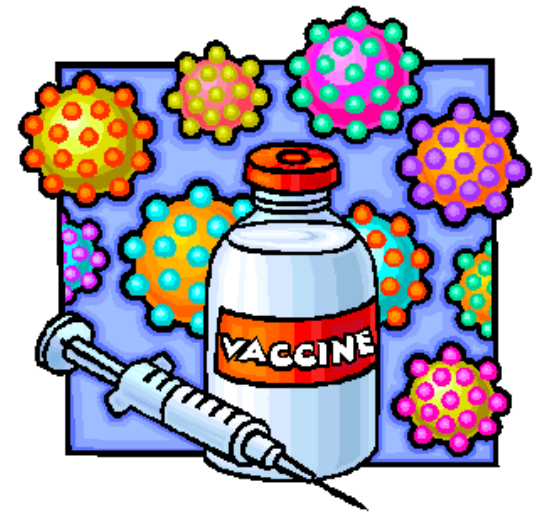

# Future directions for modelling

---

- More mathematical models are urgently needed
- Existing control efforts need to be optimised
- Theoretical interventions need to be examined
  - eg potential vaccines

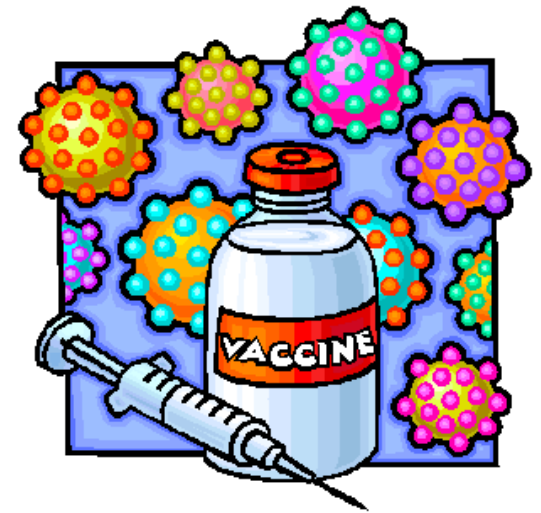

# Future directions for modelling

---

- More mathematical models are urgently needed
- Existing control efforts need to be optimised
- Theoretical interventions need to be examined
  - eg potential vaccines
- Spatial effects are crucial

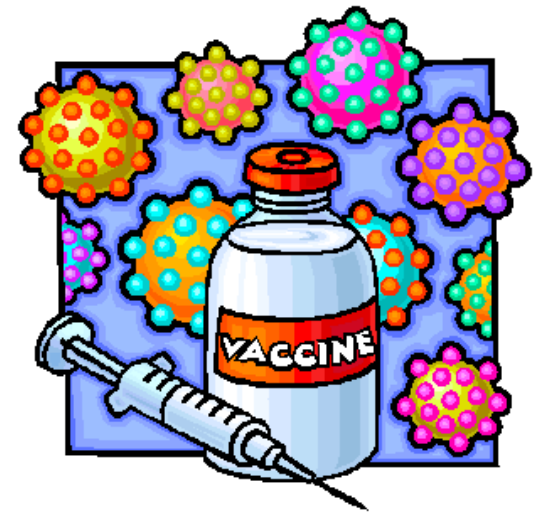

# Future directions for modelling

---

- More mathematical models are urgently needed
- Existing control efforts need to be optimised
- Theoretical interventions need to be examined
  - eg potential vaccines
- Spatial effects are crucial
- Urban/rural models

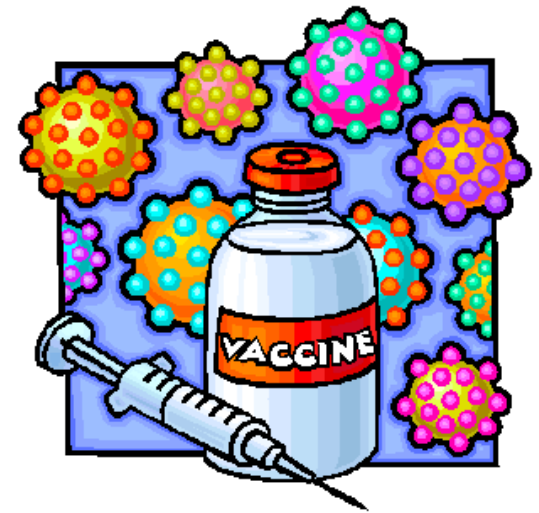

# Future directions for modelling

---

- More mathematical models are urgently needed
- Existing control efforts need to be optimised
- Theoretical interventions need to be examined
  - eg potential vaccines
- Spatial effects are crucial
- Urban/rural models
- Fill in potential gaps in knowledge

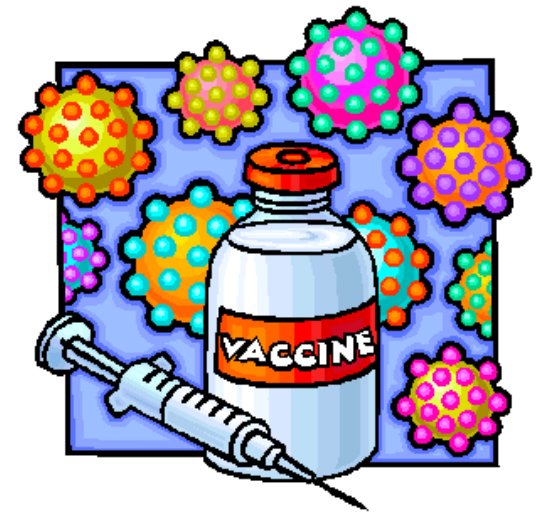

# Future directions for modelling

---

- More mathematical models are urgently needed
- Existing control efforts need to be optimised
- Theoretical interventions need to be examined
  - eg potential vaccines
- Spatial effects are crucial
- Urban/rural models
- Fill in potential gaps in knowledge
  - eg routes of transmission.

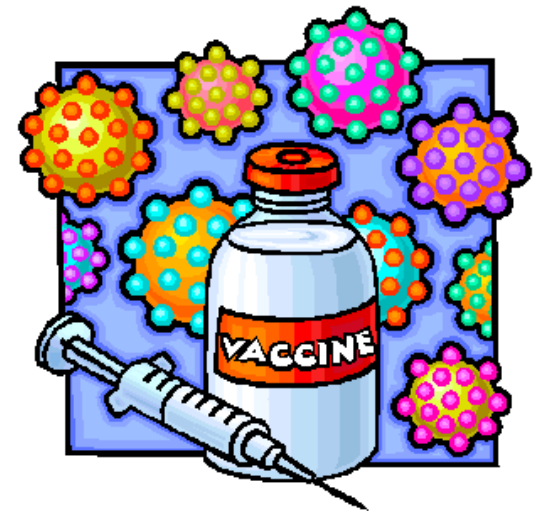

# Specific problems

---

- Adapting malaria pesticide models for vector control in Chagas' Disease



# Specific problems

---

- Adapting malaria pesticide models for vector control in Chagas' Disease
- Modelling access to resources across geographically difficult terrains



# Specific problems

---

- Adapting malaria pesticide models for vector control in Chagas' Disease
- Modelling access to resources across geographically difficult terrains
  - eg distance to hospitals, swamps, mountains, road networks



# Specific problems

---

- Adapting malaria pesticide models for vector control in Chagas' Disease
- Modelling access to resources across geographically difficult terrains
  - eg distance to hospitals, swamps, mountains, road networks
- Categorise the cost to developing economies of disabling NTDs



# Specific problems

---

- Adapting malaria pesticide models for vector control in Chagas' Disease
- Modelling access to resources across geographically difficult terrains
  - eg distance to hospitals, swamps, mountains, road networks
- Categorise the cost to developing economies of disabling NTDs
- Model NTD research funding



# Specific problems

---

- Adapting malaria pesticide models for vector control in Chagas' Disease
- Modelling access to resources across geographically difficult terrains
  - eg distance to hospitals, swamps, mountains, road networks
- Categorise the cost to developing economies of disabling NTDs
- Model NTD research funding
- Co-infection models



# Specific problems

---

- Adapting malaria pesticide models for vector control in Chagas' Disease
- Modelling access to resources across geographically difficult terrains
  - eg distance to hospitals, swamps, mountains, road networks
- Categorise the cost to developing economies of disabling NTDs
- Model NTD research funding
- Co-infection models
  - with other NTDs and the big three.



# Summary

---

- NTDs require immediate attention



# Summary

---

- NTDs require immediate attention
- NTDs extract an enormous price in



# Summary

---

- NTDs require immediate attention
- NTDs extract an enormous price in
  - suffering



# Summary

---

- NTDs require immediate attention
- NTDs extract an enormous price in
  - suffering
  - lack of economic development



# Summary

---

- NTDs require immediate attention
- NTDs extract an enormous price in
  - suffering
  - lack of economic development
  - promotion of poverty



# Summary

---

- NTDs require immediate attention
- NTDs extract an enormous price in
  - suffering
  - lack of economic development
  - promotion of poverty
- Mathematical models can be used to inform policy at minimal cost.



# Conclusions

---

- NTDs are the low-hanging fruit of disease modelling



# Conclusions

---

- NTDs are the low-hanging fruit of disease modelling
- A great many problems could be solved, relatively easily, by harnessing the power of mathematical modelling



# Conclusions

---

- NTDs are the low-hanging fruit of disease modelling
- A great many problems could be solved, relatively easily, by harnessing the power of mathematical modelling
- The price — political and otherwise — for such a huge improvement in the quality of life for 1/6 of the world's population is tiny.



# Key References

---

- P.J. Hotez (2008) *Forgotten People, Forgotten Diseases: The Neglected Tropical Diseases and Their Impact on Global Health and Development*, ASM press
- A.D. Kealey and R.J. Smith? (2010) *Neglected Tropical Diseases: Infection, Modeling, and Control*. *Journal of Health Care for the Poor and Underserved* 21, 53-69.

<http://mysite.science.uottawa.ca/rsmith43>

